

A hand with a black watch is pointing towards a miniature model of a city. The model features several white buildings and green trees on a light-colored base. The background is blurred, showing a person in a white shirt and a large white wind turbine. The overall scene is set in a bright, professional environment.

NV Embedded®
**An adaptable
solution. Naturally
intelligent.**

Indoor climate solutions

NV Embedded® is our distributed and scalable solution that controls the indoor climate based on intelligent monitoring and data storage in the cloud with the option of an app. With flexible BMS integration and support of all major fieldbus technologies, NV Embedded® is suitable for every type of building

Internet of Things in Buildings (BIIoT) is on the rise, but for the end-user to capitalize on the smart technologies, they need to be compatible and adaptable.

“The combined global market for BIIoT will grow significantly from 2016–2021 with at a CAGR of 20.7%.”

Growth in Smart Buildings Connected Devices over time (millions of devices)

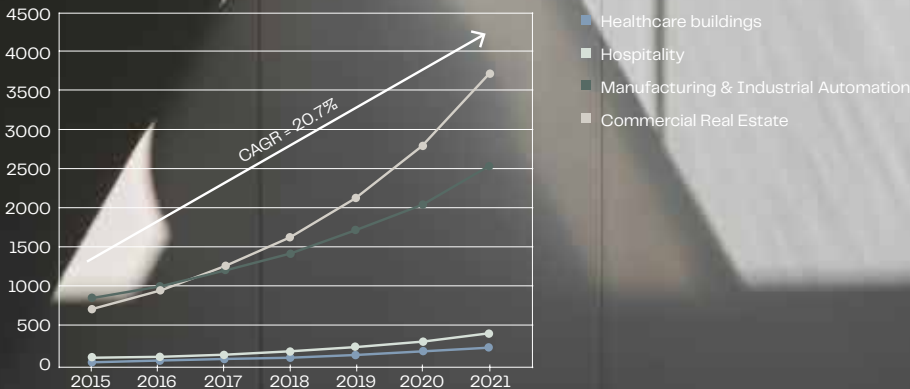

*The Internet of Things in Smart Commercial Buildings 2016 to 2021, Memoori, Smart Building Research, 2016.

The first NV Embedded® indoor climate solution was installed in 2017. The system exceeds expectations in terms of fitting the clients' needs and in its scalability and sustainability. As part of WindowMaster's commitment to delivering projects beyond practical completion, the client also benefits from our service team and remote service abilities to maintain the system for optimum performance.

Content

4	A better environment inside and outside
6	The next generation of indoor climate control – IoT and smart buildings
10	NV Embedded® at a glance
12	Advanced control strategy
14	A flexible system suitable for all
16	Solution overview
18	NV Embedded® products
20	Good for retrofitting
22	NV Embedded® features
26	Your partner throughout the process



A better environment inside and outside

A holistic and intelligent indoor climate strategy using smart building technologies and natural resources is a major contributor to a healthy environment and improved cognitive performance. It further allows building owners to significantly reduce their energy consumption and to increase building user autonomy.

Currently, buildings account for as much as 50% of energy use and 40% of carbon emissions. Therefore, there is an urgent need to address modern building processes and renovation to reduce energy

consumption and minimize running and maintenance costs. Automated indoor climate control based on intelligent software can provide a robust and reliable solution – enhancing the indoor environment, comfort, productivity, and reducing the lifetime costs of the building.

WindowMaster and automated natural ventilation
For almost 30 years, WindowMaster has supplied intelligent indoor climate control systems with effective natural ventilation and smoke ventilation solutions



to a wide range of buildings all over the world. This experience and knowledge enables us to continue to develop products and solutions that ensure the best possible indoor climate. With our demonstrated competencies across all steps of the project – from ventilation strategy and facade design, to control system design and commissioning – WindowMaster solutions are designed to meet both the design intent of the team and the technical requirements of the client.

Find out more

For further information on intelligent facade automation, WindowMaster control solutions and our consultancy services, please visit our website at **[windowmaster.com](https://www.windowmaster.com)**



The next generation of indoor climate control – IoT and smart buildings

Traditionally, non-residential buildings have been self-contained, meaning that their building automation systems, such as HVAC, have directly read inputs (via sensors) and directly controlled outputs (valves, fans, lights, etc.) to keep the building comfortable and secure.

However, the number of smart components and systems installed in buildings is growing at a rapid pace, and the trend is expected to accelerate in the years to come. Hence, to reduce complexity for the building owners and facility managers, and to reduce improperly configured Building Management Systems, it is key to connect and exchange data with IoT connectivity (Internet of Things). By using automated control mechanisms and integrated building technology, IoT fosters advanced possibilities in building technology through intelligent sensors that

measure a range of inputs from weather data to indoor CO₂ levels. Smart building technology also facilitates real-time data visibility as well as advanced analytics, which are useful for continuous monitoring, automated and remote controlling of systems, predictive analytics, and data-driven decisions.

NV Embedded® is built on the notion that IoT provides value to all parties related to the building; from the owner and operator to the end-user. Building operators and facility staff often spend a significant amount of time handling occupant comfort complaints. New technologies using IoT have revolutionized the user experience of building occupants as well as the opportunities for tracking and analyzing building data for the facility staff. In many commercial buildings, occupants have



little direct control over their environment, and building operators have little data to understand the occupants' comfort levels. NV Embedded® provides both groups with a solution by storing data in the cloud or BMS, and by enabling control via app. The app allows users to control their micro environment while the facility staff can monitor and control the HVAC of the entire building.

IoT is simply advancing a new breed of smart buildings that are better-aligned with the priorities of all stakeholders. It enables operational systems to deliver more accurate and useful information for improving operations while providing the best experience for the building's inhabitants.

“Improperly configured BMS systems are believed to account for 20% of building energy usage, or approximately 8% of total energy usage in the United States.”

Advanced Sensors and Controls for Building Applications: Market Assessment and Potential R&D Pathways (Brambley 2005)





NV Embedded® at a glance

NV Embedded® is WindowMaster's newest generation of indoor climate control solutions where the software and functionality of automated natural ventilation is embedded into the MotorController. Accordingly, no additional control unit is necessary, and you can access information about the system and the indoor climate or change settings from any device or via the app. All configuration can be done through the display of the MotorController or via a WindowMaster PC application.

The solution is suitable for all types of buildings regardless of needs and size, as NV Embedded® can be implemented as a standalone system or can easily integrate into the BMS. Furthermore, it does not require any specific fieldbus technology, but supports both BACnet, Modbus, and KNX.

It is a scalable solution that allows you to implement one or several indoor climate control features such as natural ventilation, mechanically assisted mixed-mode ventilation, wind catchers, sun shading, heating, and cooling, depending on individual requirements.

The control strategies in NV Embedded® are highly flexible and have been developed to ensure the best possible indoor climate with the lowest possible environmental impact.

New features will continuously be added to the system based on input from the market and can be easily integrated into the existing NV Embedded® via simple software updates. For a complete roadmap of feature releases, please contact WindowMaster.

NV Embedded® uses intelligent software to automatically control the indoor climate based on data input on temperature, CO₂, and humidity in each room as well as wind, rain, and outdoor temperature input from a weather station. The setpoints are determined based on what is applicable for the specific building, and hereafter the system automatically controls the indoor climate.

NV Embedded® can be configured with varying levels of BMS integration from zero to full integration and everything in between making it suitable for all types of buildings.

Automated Systems

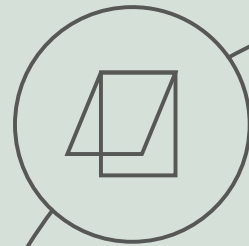

BMS Compliant

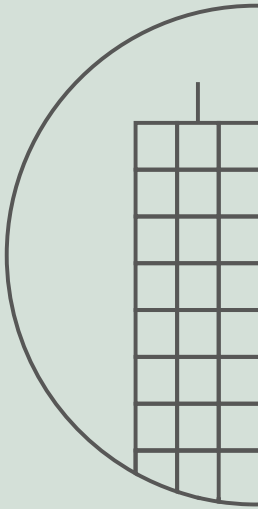



Mobile management

← A device-independent app for facility managers and end-users helps to create a comfortable indoor climate. The app allows appointed users to see and change the indoor climate settings where they are based, while it allows the facility manager to access data for the entire building, change settings and perform fast troubleshooting.

Cloud Based

← The system is accessible through a cloud-based setup, which enables remote monitoring and service.





Advanced control strategy

NV Embedded® ensures excellent indoor climates by using an advanced control strategy for precise positioning of the windows.

The strategy takes the following into consideration:

- Building location and surroundings.
- Building function.
- Wind speed and direction, outdoor temperature, and rain.
- Window facade and roof construction and the derived air streams through the windows.
- Seasonal changes.
- Temperature, relative humidity, and CO₂ level in each relevant room in the building.

The system is able to close or limit the opening of the windows when it is raining or too windy. NV Embedded® can be combined with smoke ventilation so that the same window is used for automated natural ventilation under normal circumstances and for smoke ventilation in the event of a fire.



**A flexible system
suitable for all**

What makes NV Embedded® unique?



All in one solution

It is the first 'all in one solution' with MotorController and comfort ventilation functions running on the same device.



Simple to install and commission

Configuration can be done directly from the MotorController's display. No other tools needed.



Scalable intelligent system

Contains distributed logic. No master control panel required.



Integration to nearly all BMS

Easy to integrate with a wide range of Building Management Systems.

NV Embedded® does not require any specific fieldbus technology, but can use both BACnet, Modbus and KNX depending on the level of BMS integration. As a result, NV Embedded® is both flexible and scalable and can be adapted to fit your specific needs and building type.

The varying levels of integration are created to fit the needs of all building sizes and types from small kindergartens to large shopping complexes, museums, and office buildings. The level of integration depends on the building's current solution and needs.

NV Embedded® connects sensors and weather stations directly to the MotorController via WSK-Link™ or fieldbus, hence no additional power supply is required. The embedded natural ventilation logic is unlocked in the MotorController via an encrypted USB dongle.

Based on preference, data can be logged by the BMS or in the cloud. Ventilation schedules' set points, and the MotorController's degree of functionality can be decided either directly by NV Embedded®, or by the BMS.

Solution overview with two example scenarios

1

A stand-alone solution – no BMS integration

- Control of natural ventilation, mixed mode ventilation (incl. mechanical ventilation), heating and solar shading.
- Indoor sensors are connected directly to the MotorController via WSK-Link™.
- Weather station is connected directly to the MotorController.
- Outdoor temperature sensor is connected directly to the room sensor.
- Log data are saved in the cloud.
- Configuration is done on the MotorController's display and / or from a PC.

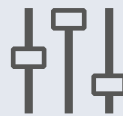

Intelligent indoor climate controller

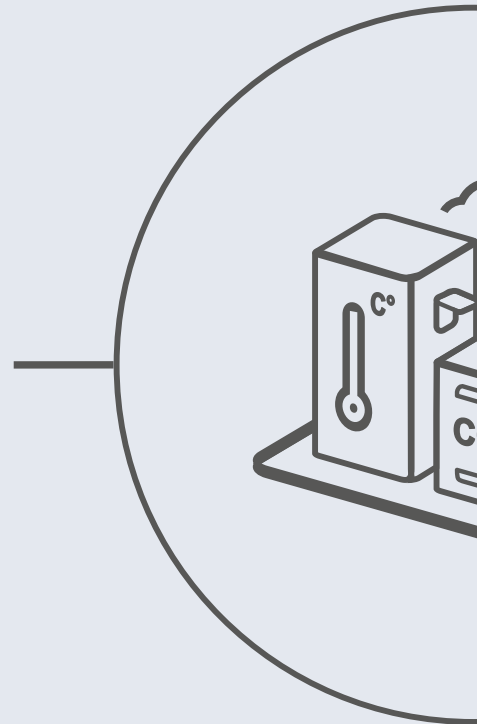

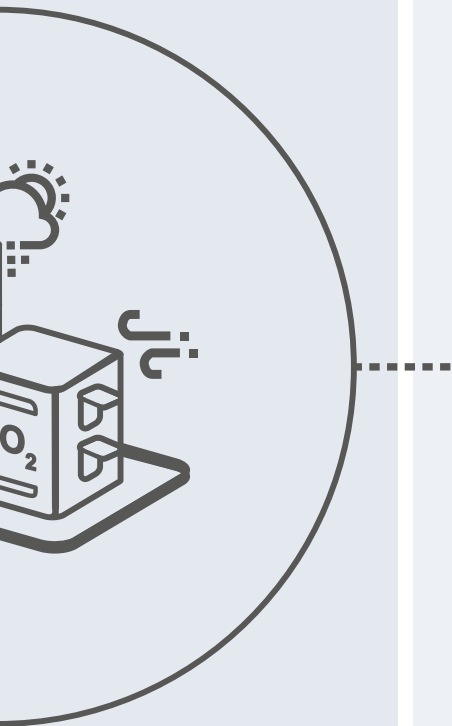

2 Part of BMS solution – through BACnet, KNX or Modbus



Optional: Integration with BMS

- Depending on the configuration, NV Embedded® can either interface to BMS through KNX, BACnet or Modbus to be fully integrated in the BMS through the system.
- NV Embedded® controls natural ventilation, mixed mode ventilation (incl. mechanical ventilation), heating, cooling, and solar shading. Or BMS decides ventilation schedules, set points, and the MotorController's degree of functionality.
- Indoor sensors are connected directly to the MotorController via WSK-Link™ or on fieldbus e.g. KNX or indoor room data is supplied by BMS.
- Weather station is connected directly to the MotorController or weather data is supplied by BMS.
- Data logging in the cloud or by BMS.

NV Embedded® products

NV Embedded® is customizable
with a range of products

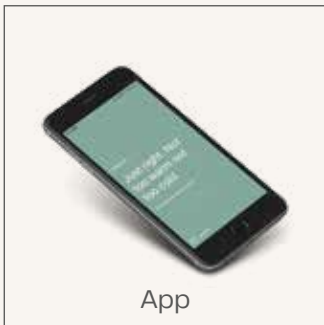

App



USB dongle



MotorController

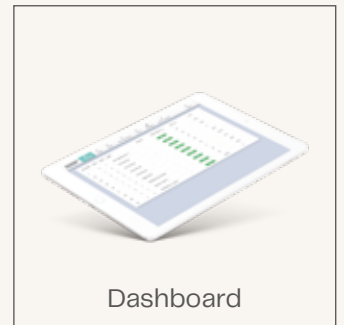

Dashboard

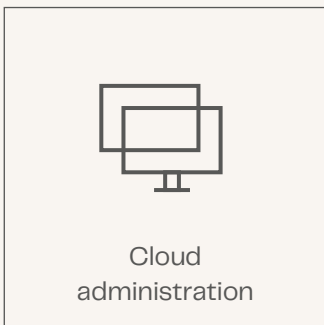

Cloud
administration



Sensor



Weather station







Good for retrofitting

One of the best ways to retrofit older buildings is to implement a software technology solution that causes the least disruption to its operations. NV Embedded® is scalable and can be implemented in steps, and accordingly does not require an entire building to shut down for long periods while refurbishment takes place. In comparison to most mechanical solutions, which often require large areas to be closed down for the aggregates to be installed, window actuators used for automated natural ventilation are installed onto or in the window frames, and the deployment can be completed very quickly. Building occupants and operations will thereby experience minimal disruption and relocation while renovation takes place can be avoided.

Modernizing buildings with NV Embedded® gives the facility managers, building owners, and operators extended visibility into the entire building. The intelligent data collection and storage provide a single access point and equip everyone with a user-friendly dashboard.

By retrofitting old buildings with NV Embedded®, building owners will be able to meet their energy efficiency goals, reduce operating expenses, and help create a sustainable environment.



NV Embedded® features



Unique MotorLink® / TrueSpeed™ technology

By using MotorLink® and TrueSpeed™ technologies, NV Embedded® operates with millimeter-by-millimeter precision and gives feedback from each single actuator. The solution offers genuine synchronization between multiple actuators on the same window as well as three different operation speeds that can be applied according to demand for quiet operation.



In control solutions with MotorLink® or TrueSpeed™ there is digital data communication to every single window actuator. The large range of functionality available within the technologies enables a more robust, flexible, and intelligent control solution to meet the individual project requirements.

For more information about the MotorLink® technology and TrueSpeed™, please visit windowmaster.com



Accurate surveillance of the indoor climate

NV Embedded® constantly monitors both the indoor climate and the outside weather conditions; thereby adjusting the amount of ventilation and keeping the indoor climate at a comfortable level. Indoor sensors in all zones register temperature, humidity, and CO₂ levels, and a weather station collects data from the outside. Similarly, lux sensors and temperature measurements inform solar shading about the optimal positioning of screens.



Accurate programming for effective automation

A balanced indoor climate is dependent on constant control of the exact position of the windows to maintain the target levels of temperature, humidity, and CO₂. To achieve this, NV Embedded® uses a unique combination of CFD analysis, proven programming, and position feedback to consistently match ventilation rates according to changing demand in the spaces and the driving (and often limiting) factors of outside weather conditions.



Mobile app

The end-user app provides the occupant with information about the room climate and enables manual override. The app is first and foremost a tool to effectively visualize and control the indoor environmental quality, notifying the user why and when windows open.

Usability and transparency increase the users' awareness of the indoor climate, heightening the level of satisfaction.

A dashboard version is available for facility managers, who can access and evaluate data about the entire building, change settings, and quickly identify fault indicators.

A user profile for each relevant occupant must be created before use by the facility manager or other building administrator. This way, a high level of safety is maintained and access to the system by unwanted users can be avoided. The App is available with Android and IOS.



Data Logging

NV Embedded® provides continuous logging and storage of all data concerning interior climate, weather conditions, window positions, and any system errors. The gathered data can then be analyzed and compared at any time, later playing an active role in adjustments to the system and troubleshooting.

With NV Embedded®, data access is easier than ever. Using the cloud to improve building automation infrastructure and access to indoor climate data is beneficial for the facility staff who can monitor the performance, and for building owners who can keep track of the environment at their specific location.



Integrated smoke ventilation

Many buildings are subject to statutory requirements for the opening of windows in the event of fire. NV Embedded® can incorporate smoke ventilation control with natural ventilation control, which means that the same equipment could be used for both functions in the case of a tested solution. WindowMaster offers a range of EN 12101-certified products. Please contact us if you have questions about tested solutions with profiles and actuators.



Building Scheduler

This is as a weekly scheduler with up to 8 time schedules per day which enables NV Embedded® to create ventilation schedules or programs. NV Embedded® can then account for the occupation, security, and time of day status of the building, ensuring that the windows only open when it makes sense.



Night cooling

Night cooling can be a critical component during summer to enhance the performance of any naturally ventilated building.

Small openings that satisfy security requirements allow the cooler nighttime air to enter the building while removing heat and energy from the internal fabric of the building. This cooling allows the structure to re-absorb some of the internal heat gains the following day, thereby reducing the daytime air temperatures to more comfortable levels. Thermal mass enhances the benefit of night cooling, but even a lightweight building can see a 30% reduction in the number of hours at higher temperatures.

Night cooling is achieved through operable windows or louvres being opened for a pre-set period of time over night. This allows a natural air flow through the building that decreases the temperature to a defined point, all while ensuring that the actuators never open further than the insurance company or security concerns allow.

WindowMaster can advise on a range of solutions to overcome security concerns, such as vent location, selective use of louvres, internal courtyards, integrating with CCTV, and PIR detectors for a fully intelligent and secure night cooling strategy.



Trickle ventilation

This is a supplement to pulse ventilation which allows for a more active and nuanced approach to air change for lowering CO₂ levels. When trickle ventilation

is activated, the windows will remain open, but only a tiny bit, until the desired CO₂ level is reached. This feature helps the room to ventilate without draft because max window opening can also be set during trickle ventilation.



Modeling wind pressure for the optimum indoor climate

From aircraft design and Formula 1 aerodynamics to window automation solutions, modern computing power and software bring us accessible and effective tools to better understand how things will react under different conditions – and thereby to accurately predict and better control the outcome. CFD (Computational Fluid Dynamics) offers a time- and cost-effective way of simulating the interaction between weather variables and building characteristics to effectively program the control system.

Using CFD to model the wind pressure around a building can effectively reduce the time spent trying to write individual algorithms for each set of windows. It gives accurate profiles to follow with predictable, and therefore, controllable and desirable outcomes, even as variables change, instead of having to use a trial-and-error-based approach until the desired outcome might be achieved.

NV Embedded® uses this in a proven approach. The results of the CFD analysis form the basis of wind pressure coefficients (C_p values) for each window for a total of 16 different wind directions. These parameters, according to the demand for ventilation in each space, form an active part of the control algorithms in

the NV Embedded® software. The required opening angle of each window is calculated based on wind direction and wind speed affecting that room, and the demand for ventilation within it.



Additional controls

The NV Embedded® system can also be set up to control other installations such as wind catchers, air conditioning units (mixed mode ventilation), louvres, etc.



Heating / cooling control

NV Embedded® can control heating and cooling for a holistic approach to the indoor climate. Heating and cooling are closely linked to the natural ventilation control, which ensures that the NV Embedded® system can minimize for example heat energy loss in the winter while it uses automated natural ventilation to create a high-quality indoor climate. Heating/cooling control includes valves to control water flow in radiators or under-floor heating, temperature sensors, and temperature control software.



Solar screening

Effective control of the sun screening is an important contributor to maintaining a comfortable indoor climate as the screens can be used as both a shield against extreme overheating and as additional insulation in the winter. NV Embedded® has a built-in sun-screening controller for venetian blinds and awnings. The controller includes functions such as a timed up/down function linked to a calendar, up/down function depending on lux levels (alternatively watt/m²), and the option of manual input.

Your partner throughout the process



Design and project planning

WindowMaster provides consultancy services and support – from the architect's very first drawing to installation and operation. Our consultants detail the proposed solutions which are always tailored to each project to visualize the air change rates possible with natural ventilation.

Our consultants are able to help with:

- Assessment of projects in the planning phase.
- Proposals for complete solutions.
- Indoor climate and CFD calculations.
- Facade and skylight design.
- Dimensioning of openings for smoke and natural ventilation.
- Turnkey solutions.

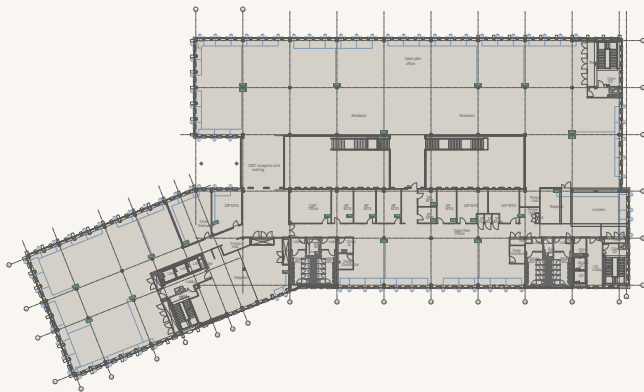

The solution

Our solutions have been developed on the basis of partnerships with recognised research institutes and practical experience from a wide range of construction projects. By monitoring climatic conditions both externally and internally (including temperature, CO₂, humidity and wind), the NV Embedded® system adjusts the indoor climate automatically by quietly, safely and accurately opening and closing windows by precise incremental amounts. The building is divided into climate zones which are controlled and monitored individually by the control system to ensure that the climate in each zone can be adjusted as required.

The system contains a wide range of options and can be installed using:

- Natural Ventilation
- Mixed Mode Ventilation
- Night cooling
- Sun shades
- Heating systems
- Cooling systems
- Automatic window openers
- Project-adapted control system

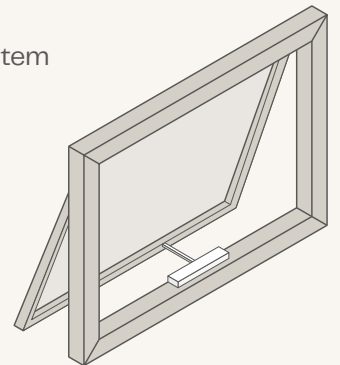



Implementation

WindowMaster is happy to manage the installation and commissioning of the NV Embedded® solution – either by using our own skilled engineers or one of our highly-trained partners. We assist with the setting of the system's many parameters, carry out a complete initialization, and issue operational and maintenance documentation.

We can assist with design support across disciplines, and when delivering a complete turnkey package, WindowMaster will manage the project right up to handing over the finished solution to the customer with clear instructions for operation. And with single source supply, there's time saved on coordinating between suppliers as well as the reassurance that the products are perfectly matched to interact smoothly.

Our engineers are able to help with:

- Simulations.
- Installation.
- Commissioning and testing.
- Handover, user training and instruction.



Follow-up and service

WindowMaster's indoor climate systems have been developed to function reliably year after year. Nevertheless, components such as actuators, power supplies, controllers and above all, the interaction between window openers and window fixtures should be regularly inspected. This is why we are available for regular service visits and repairs. We also offer service agreements tailored to the customer's requirements. All service agreements include a telephone hotline that ensures fast support during office hours.

Our service technicians are able to help with:

- Service, maintenance and functional testing of components.
- Software maintenance and updates.
- Remote service, system changes, fault identification and backup.
- Regular monitoring and adjustment.
- Event logging.
- Indoor climate support with optimization recommendations.



WindowMaster aspires to protect people and the environment by creating a healthy and safe indoor climate, automatically ventilating spaces with fresh air through facade and roof windows in commercial buildings. We offer the construction industry foresighted, flexible and intelligent window actuators and control systems for natural ventilation, mixed mode ventilation and smoke ventilation – of the highest quality.

WindowMaster employs highly experienced cleantech specialists in Denmark, Norway, Germany, United Kingdom, Ireland, Switzerland and United States of America. In addition, we work with a vast network of certified partners. With our extensive expertise built up since 1990, WindowMaster is ready to help the construction industry meet its green obligations and achieve their architectural and technical ambitions.w

windowmaster.com